

# 5포트 파일럿형 솔레노이드 밸브 (SV)

## SV3000 시리즈 (Rc(PT) 1/4)

- 보디폭 26.5mm
- 통과유량 1000 l/min (5bar)



### 주문형식

SV 3 1 30-220V-GL-P-02

- ① 솔레노이드밸브
- ② 전환방식
  - 1 - 2위치 싱글
  - 2 - 2위치 더블
  - 3 - 3위치 Closed Center
  - 4 - 3위치 Exhaust Center
  - 5 - 3위치 Pressure Center
- ③ 정격전압
  - 220V - AC 220V
  - 110V - AC 110V
  - 24V - AC 24V
  - D24V - DC 24V
- ④ 코일종류
  - 무기호 - 코일없음
  - G - 리드선방식
  - GL - 램프장착 리드선방식
  - C - 3 Pin 코일 + 커넥터
  - CL - 3 Pin 코일 + 램프커넥터
- ⑤ 수동조작방식
  - P - 푸시버튼
- ⑥ 나사종류
  - 무기호 - Rc(PT)
  - N - NPT
  - G - G(PF)
- ⑦ 관접속구경
  - 02 - Rc(PT) 1/4(P, A, B), 1/8(R1, R2)

### 표시기호

2 Position Single



3 Position Closed Center



2 Position Double

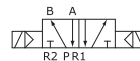

3 Position Exhaust Center

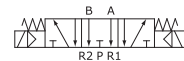

3 Position Pressure Center

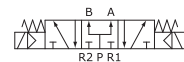

### 표준사양

항목	5포트 2위치	5포트 3위치
사용유체	압축공기	
주위 및 사용유체온도	5 ~ 60℃	
사용압력	1.5~10bar	2~10bar
유효단면적(5bar시)	19mm <sup>2</sup>	11.5mm <sup>2</sup>
응답시간(5bar시)	25ms 이하	35ms 이하
최대작동빈도	5c/sec	3c/sec
급유	불필요(단, 급유시 터빈유 1종 (ISO VG32))	
수동조작	누름식버튼	
코일절연의종류	F종상당	
허용전압변동	정격전압의±10%	
소비전력	AC:4.9VA(60Hz) / DC:2.5W	

외형치수도(mm)

2위치 / 5포터 싱글형( 그로매트 타입)

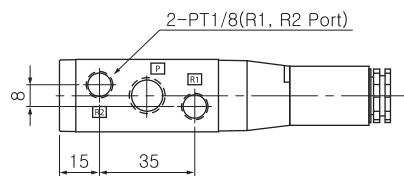
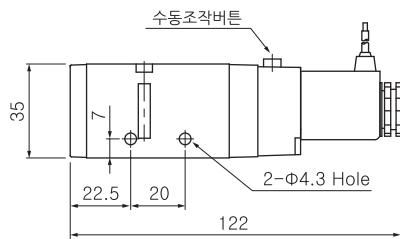
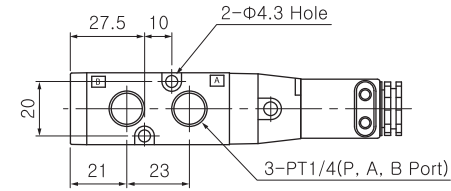

SV3130-□□□V-G-...

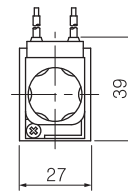
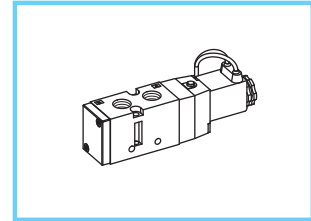

2위치 / 5포터 싱글형(램프 타입)

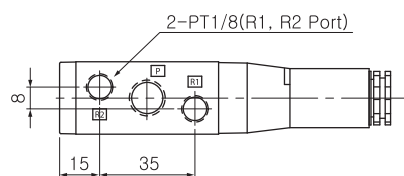
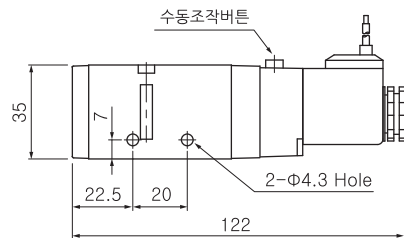
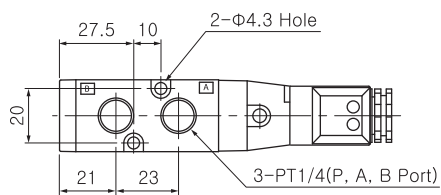

SV3130-□□□V-GL-...

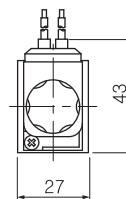
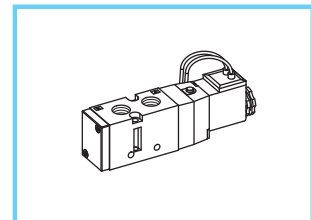

외형치수도(mm)

2위치 / 5포터 싱글형(커넥터 타입)

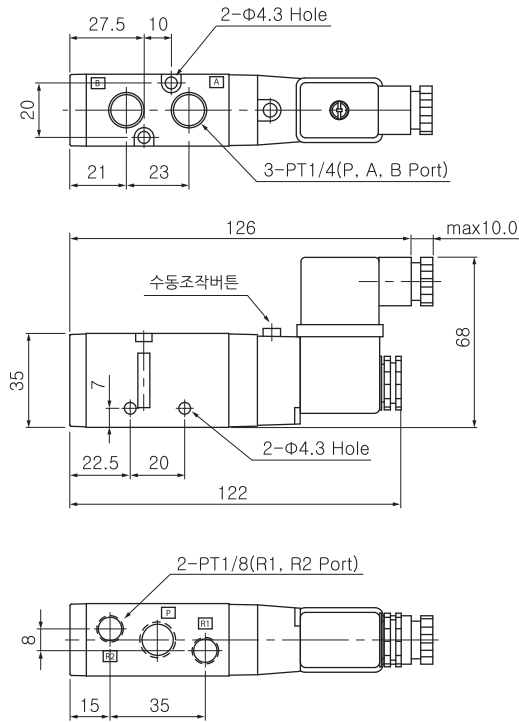

SV3130-□□□V-C□-...

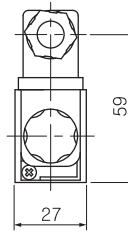
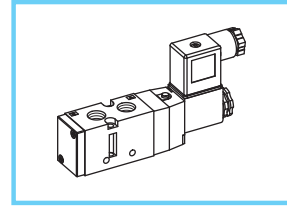

2위치 / 5포터 더블형(그로맷 타입)

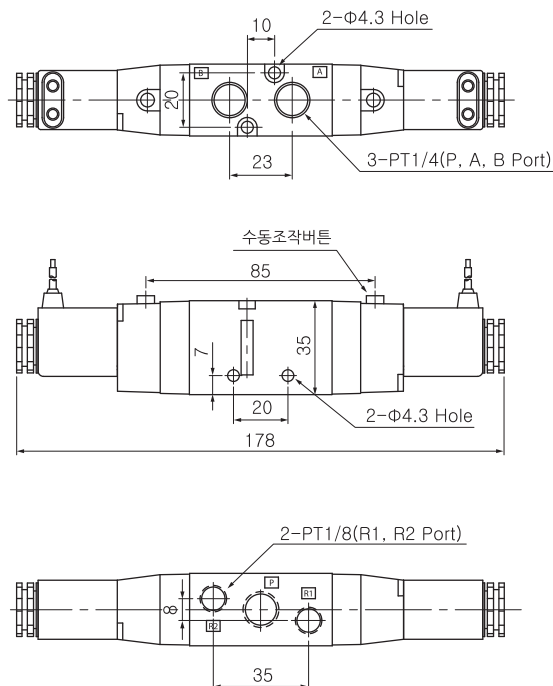

SV3230-□□□V-G-...

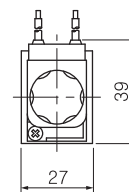
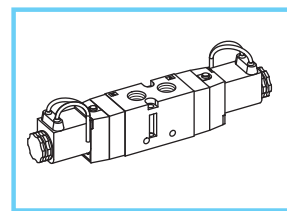

외형치수도(mm)

3위치 / 5포터 더블형(그로메트 타입)

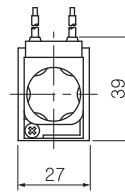
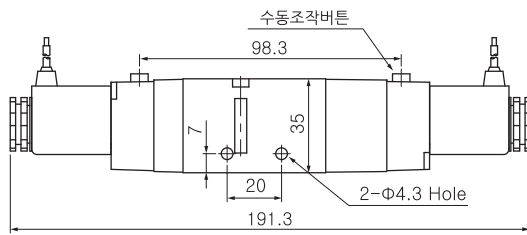
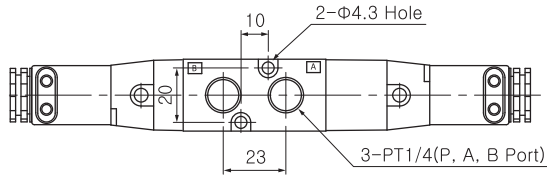

SV3330-□□□V-G...

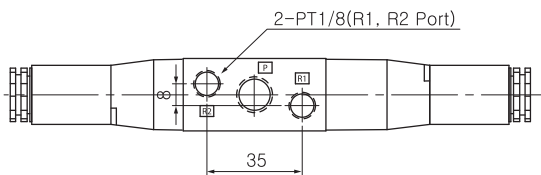
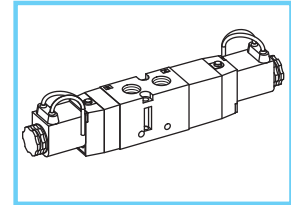

3위치 / 5포터 더블형(램프 타입)

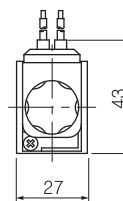
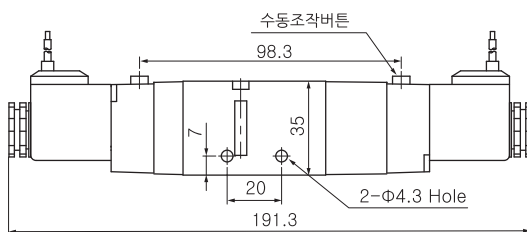
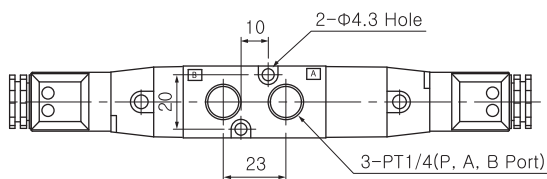

SV3330-□□□V-GL...

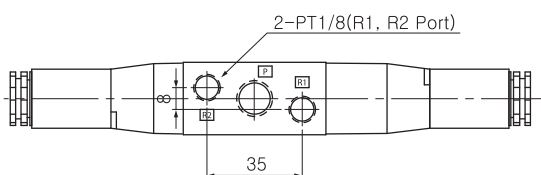
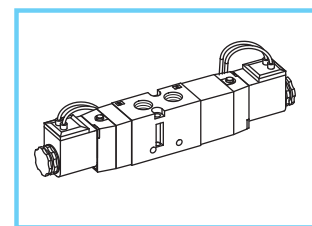

외형치수도(mm)

3위치 / 5포터 더블형(커넥터 타입)

SV3330-□□□V-C□-...

